

Condensing Unit Technical Data Sheet

Model CML80TB_N
Voltage 220-240V 50Hz ~1
Refrigerant R404A

APPLICATION

Application High-Medium Back Pressure
 Refrigerant R404A
 Evaporating Temp. -25,0 °C to 10,0 °C
 Expansion Capillar/Valve
 Comp. Cooling Fan cooled
 Max. ambient temp. 43,0 °C

COMPRESSOR

Displacement 7,57 cm³
 Diameter 25,40 mm
 Stroke 14,92 mm
 Oil type ISO VG 32 ESTER
 Oil charge 395 cm³

MOTOR

Nominal Power 3/8 hp
 Voltage/Frequency 220-240V 50Hz
 Voltage range 198-255 V
 Type CSIR
 Phase number 1 PH
 Locked Rotor Amps (LRA) 12,80 A
 Max. Cont. Current (MCC) 5,10 A
 Main W. resist. at 25°C 7,75 Ω
 Start W. resist. at 25°C 21,43 Ω

NOMINAL PERFORMANCE

Cooling Capacity	1.170 W
COP	2,05 W/W
EER	1,76 kCal/Wh
Input Power	572 W
Current	3,02 A

ASHRAE

TEST CYCLE CONDITIONS

	HMBP
Evaporating temp. (T _e)	7,2 °C
Condensing temp. (T _c)	55,0 °C
Liquid temp. (T _{liq.})	46,0 °C
Ambient temp. (T _{amb.})	35,0 °C
Suction temp. (T _{suction})	35,0 °C
Voltage/Frequency	220 V 50 Hz

CONDENSER AND FAN DATA

Condenser type	CU-AL
Condenser model	9T 4R
Fan blade (Ø mm / °)	230 / 28
Fan motor	10W 230V 50/60Hz

WIRING DIAGRAM

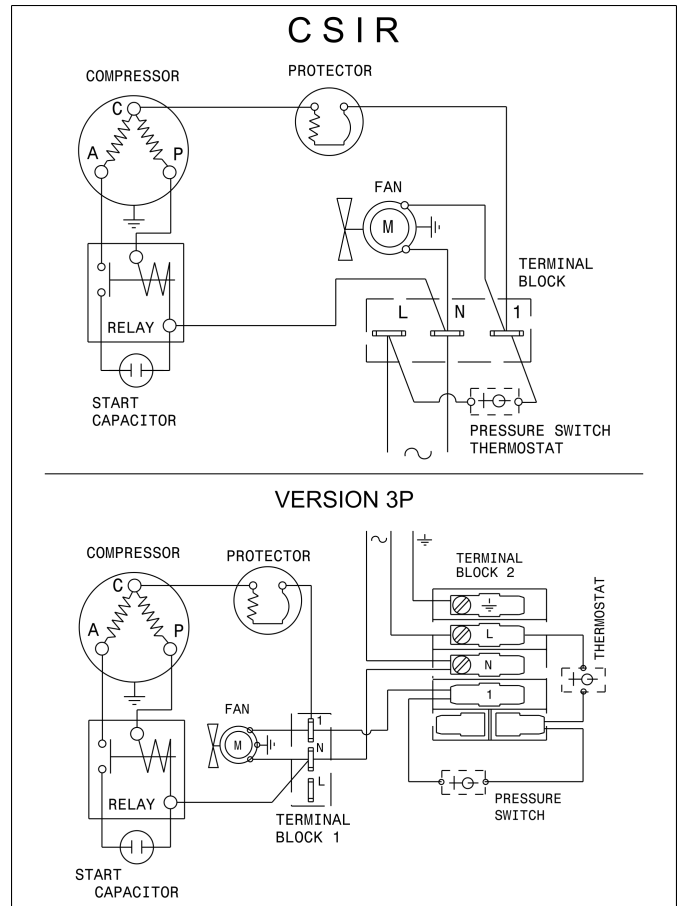

REFRIGERATION CAPACITY (W) Evaporating Temperature (°C)

Model	Motor	-25	-15	-5	5	7.2			10
						W	Winp	A	
CML80TB_N	CSIR	408	567	795	1094	1170	572	3.02	1271

ASHRAE HMBP: Condensing temperature: 55°C, Liquid temperature: 46°C, Suction temperature: 35°C, Ambient temperature: 35°C

Condensing Unit Technical Data Sheet

VERSIONS

VERSION 1	VERSION 2	VERSION 3	VERSION 3P	VERSION 4
Tube	Service valve	Service valve and receiver	Service valve, receiver, pressure switch	Schrader valve on the service port
Suction tube internal diam.: 6,5 mm Discharge tube internal diam.: 4,9 mm Net Weight: 22,7 Kg	Suction valve: 3/8" Discharge valve: 1/4" Net Weight: 23,2 Kg	Receiver vol.: 0,9 l Suction valve: 3/8" Discharge valve: 1/4" Net Weight: 23,5 Kg	Receiver vol.: 0,9 l Suction valve: 3/8" Discharge valve: 1/4" Net Weight: 24,6 Kg	Suction tube internal diam.: 6,5 mm Discharge tube internal diam.: 4,9 mm Net Weight: 22,7 Kg

DIMENSIONS (Version 3 drawing)

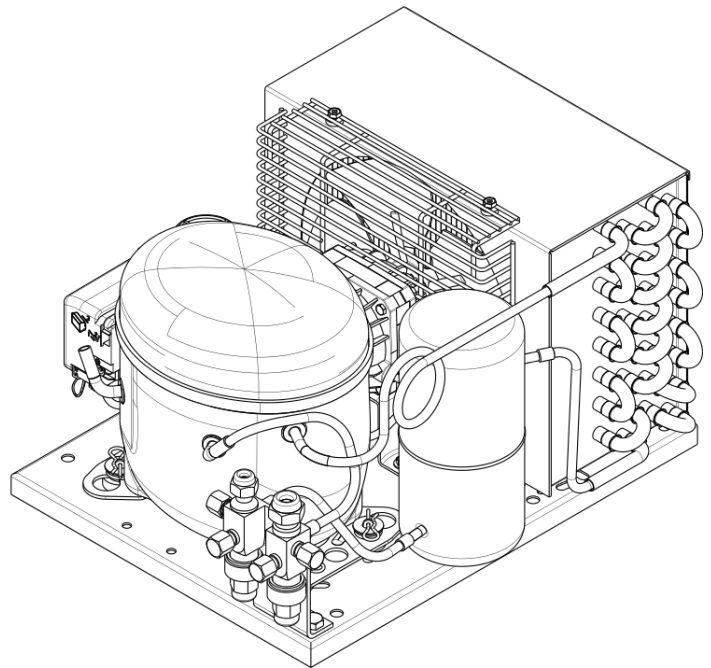
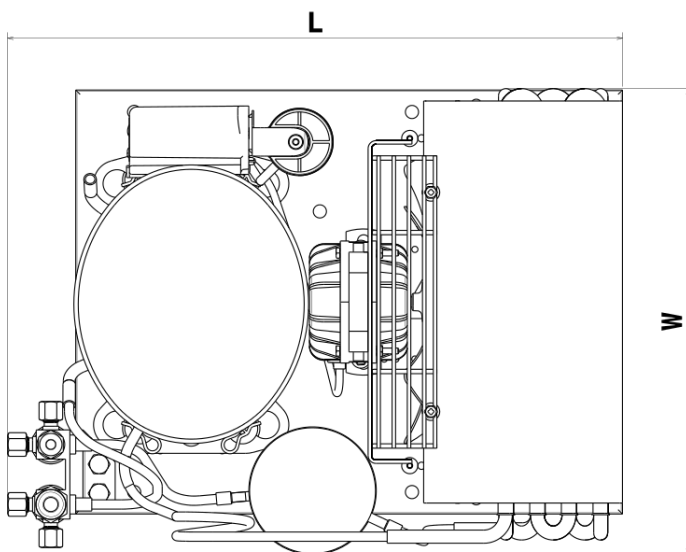
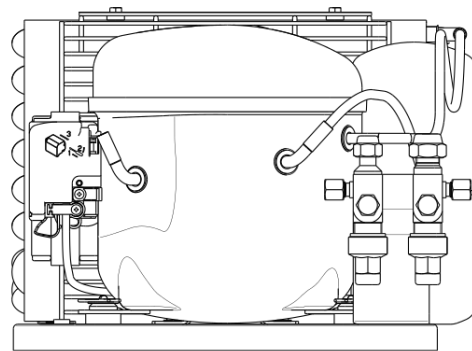
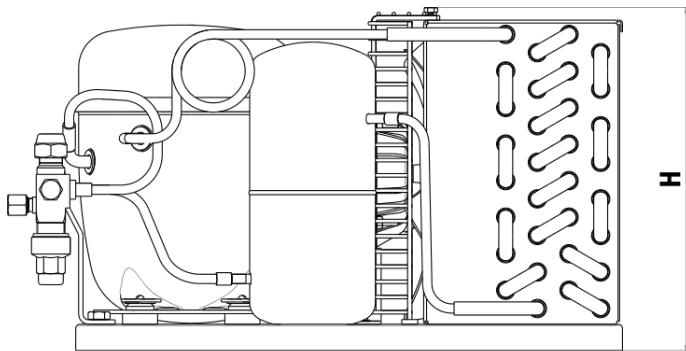

VERSION 1-4 (WxLxH) (mm)	VERSION 2 (WxLxH) (mm)	VERSION 3 (WxLxH) (mm)	VERSION 3P (WxLxH) (mm)
325x415x275	325x455x275	330x455x275	340x465x275