

Condensing Unit Technical Data Sheet

Model CMS26TB_N
Voltage 220-240V 50Hz ~1
Refrigerant R404A

APPLICATION

Application High-Medium Back Pressure
 Refrigerant R404A
 Evaporating Temp. -25,0 °C to 10,0 °C
 Expansion Capillar/Valve
 Comp. Cooling Fan cooled
 Max. ambient temp. 43,0 °C

COMPRESSOR

Displacement 25,93 cm³
 Diameter 39,98 mm
 Stroke 20,65 mm
 Oil type ISO VG 46 ESTER
 Oil charge 887 cm³

MOTOR

Nominal Power 1 3/8 hp
 Voltage/Frequency 220-240V 50Hz
 Voltage range 187-255 V
 Type CSR
 Phase number 1 PH
 Locked Rotor Amps (LRA) 38,00 A
 Max. Cont. Current (MCC) 11,50 A
 Main W. resist. at 25°C 1,65 Ω
 Start W. resist. at 25°C 4,90 Ω

NOMINAL PERFORMANCE

Cooling Capacity	3.668 W
COP	2,06 W/W
EER	1,77 kCal/Wh
Input Power	1.778 W
Current	8,03 A

ASHRAE

TEST CYCLE CONDITIONS

	HMBP
Evaporating temp. (T _e)	7,2 °C
Condensing temp. (T _c)	55,0 °C
Liquid temp. (T _{liq.})	46,0 °C
Ambient temp. (T _{amb.})	35,0 °C
Suction temp. (T _{suction})	35,0 °C
Voltage/Frequency	220 V 50 Hz

CONDENSER AND FAN DATA

Condenser type	CU-AL
Condenser model	14T 3R
Fan blade (Ø mm / °)	300 / 27
Fan motor	85W 230V 50/60Hz

WIRING DIAGRAM

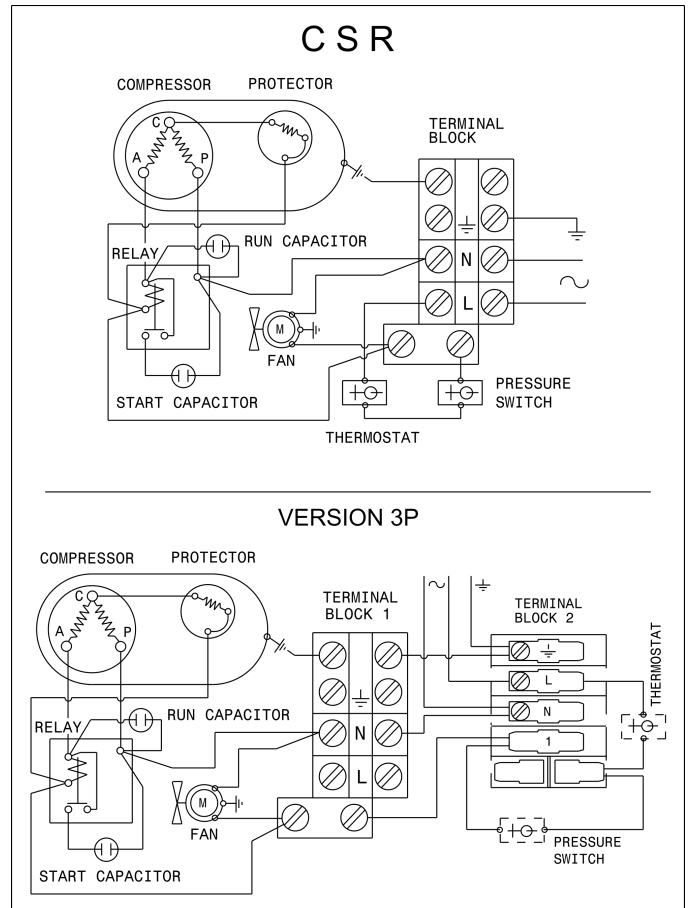

REFRIGERATION CAPACITY (W) Evaporating Temperature (°C)

Model	Motor	-25	-15	-5	5	7.2			10
						W	Winp	A	
CMS26TB_N	CSR	1183	1853	2615	3468	3668	1778	8.03	3930

ASHRAE HMBP: Condensing temperature: 55°C, Liquid temperature: 46°C, Suction temperature: 35°C, Ambient temperature: 35°C

Condensing Unit Technical Data Sheet

VERSIONS

VERSION 1	VERSION 2	VERSION 3	VERSION 3P	VERSION 4
Tube	Service valve	Service valve and receiver	Service valve, receiver, pressure switch	Schrader valve on the service port
Suction tube internal diam.: 12,7 mm Discharge tube internal diam.: 8,0 mm Net Weight: 38,7 Kg	Suction valve: 5/8" Discharge valve: 3/8" Net Weight: 39,7 Kg	Receiver vol.: 2,4 l Suction valve: 5/8" Discharge valve: 3/8" Net Weight: 41,2 Kg	Receiver vol.: 2,4 l Suction valve: 5/8" Discharge valve: 3/8" Net Weight: 42,3 Kg	Suction tube internal diam.: 12,7 mm Discharge tube internal diam.: 8,0 mm Net Weight: 38,7 Kg

DIMENSIONS (Version 3 drawing)

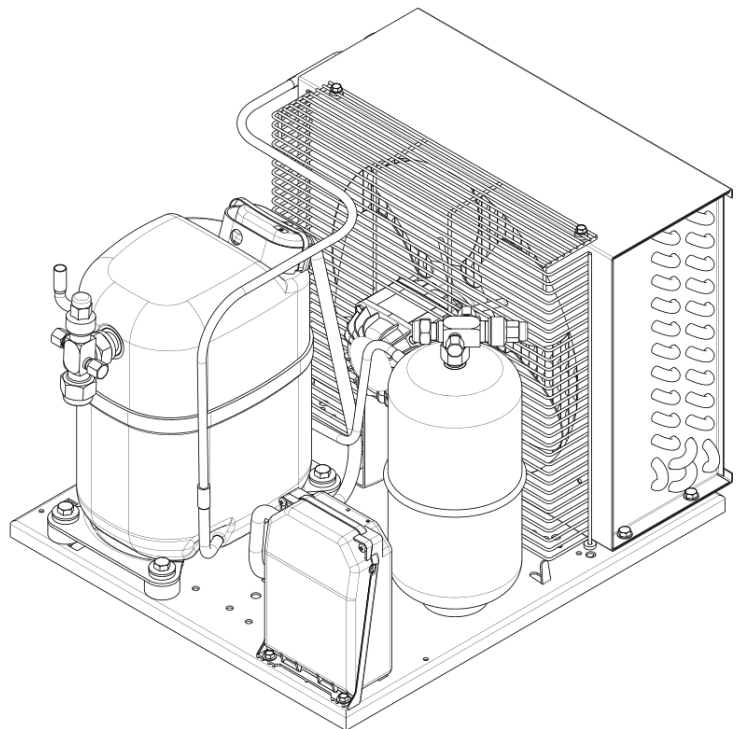
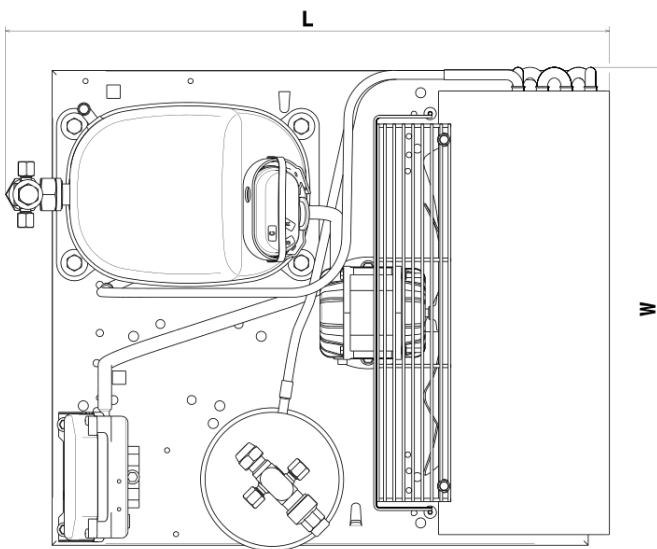
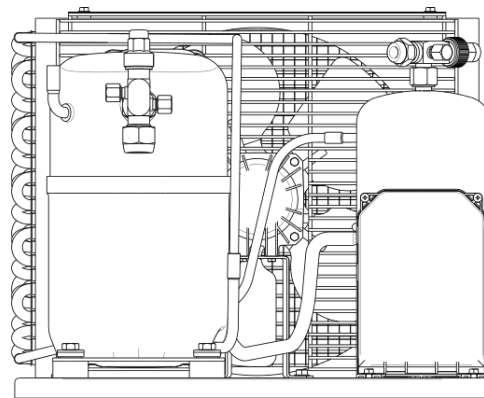
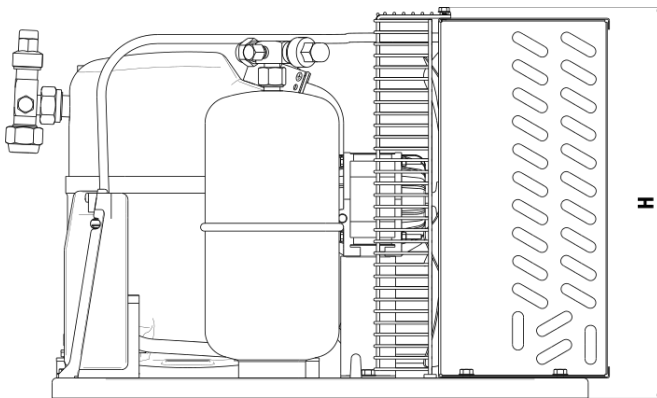

VERSION 1-4 (WxLxH) (mm)	VERSION 2 (WxLxH) (mm)	VERSION 3 (WxLxH) (mm)	VERSION 3P (WxLxH) (mm)
460x505x375	460x535x375	460x535x375	460x535x375