

Condensing Unit Technical Data Sheet

Model CNUY45RAa_N
Voltage 220-240V 50Hz ~1
Refrigerant R290

APPLICATION

Application High-Medium Back Pressure
 Refrigerant R290
 Evaporating Temp. -25,0 °C to 10,0 °C
 Expansion Capillar/Valve
 Comp. Cooling Fan cooled
 Max. ambient temp. 43,0 °C

COMPRESSOR

Displacement 4,50 cm³
 Diameter 21,99 mm
 Stroke 11,88 mm
 Oil type ISO VG 32 ESTER
 Oil charge 220 cm³

MOTOR

Nominal Power 1/5 hp
 Voltage/Frequency 220-240V 50Hz
 Voltage range 187-255 V
 Type CSIR
 Phase number 1 PH
 Locked Rotor Amps (LRA) 10,50 A
 Max. Cont. Current (MCC) 1,80 A
 Main W. resist. at 25°C 9,79 Ω
 Start W. resist. at 25°C 37,10 Ω

NOMINAL PERFORMANCE

Cooling Capacity	645 W
COP	2,59 W/W
EER	2,23 kCal/Wh
Input Power	249 W
Current	1,44 A

ASHRAE

TEST CYCLE CONDITIONS

	HMBP
Evaporating temp. (T _e)	7,2 °C
Condensing temp. (T _c)	55,0 °C
Liquid temp. (T _{liq.})	46,0 °C
Ambient temp. (T _{amb.})	35,0 °C
Suction temp. (T _{suction})	35,0 °C
Voltage/Frequency	220 V 50 Hz

CONDENSER AND FAN DATA

Condenser type	CU-AL
Condenser model	8T 2R
Fan blade (Ø mm / °)	200 / 28
Fan motor	5W 230V 50/60Hz

WIRING DIAGRAM

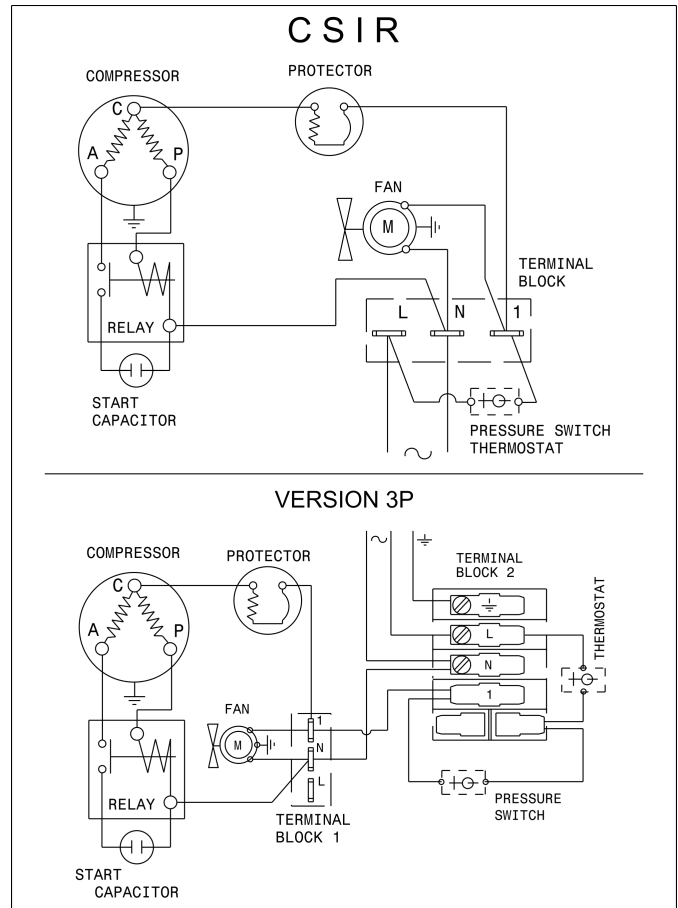

REFRIGERATION CAPACITY (W) Evaporating Temperature (°C)

Model	Motor	-25	-15	-5	5	7.2			10
						W	Winp	A	
CNUY45RAa_N	CSIR	190	290	427	602	645	249	1.44	703

ASHRAE HMBP: Condensing temperature: 55°C, Liquid temperature: 46°C, Suction temperature: 35°C, Ambient temperature: 35°C

Condensing Unit Technical Data Sheet

VERSIONS

VERSION 1	VERSION 2	VERSION 3	VERSION 3P	VERSION 4
Tube	Service valve	Service valve and receiver	Service valve, receiver, pressure switch	Schrader valve on the service port
Suction tube internal diam.: 6,5 mm Discharge tube internal diam.: 4,9 mm Net Weight: 22,9 Kg	Suction valve: 3/8" Discharge valve: 1/4" Net Weight: 23,4 Kg	Receiver vol.: 0,9 l Suction valve: 3/8" Discharge valve: 1/4" Net Weight: 23,7 Kg	Receiver vol.: 0,9 l Suction valve: 3/8" Discharge valve: 1/4" Net Weight: 24,8 Kg	Suction tube internal diam.: 6,5 mm Discharge tube internal diam.: 4,9 mm Net Weight: 22,9 Kg

DIMENSIONS (Version 3 drawing)

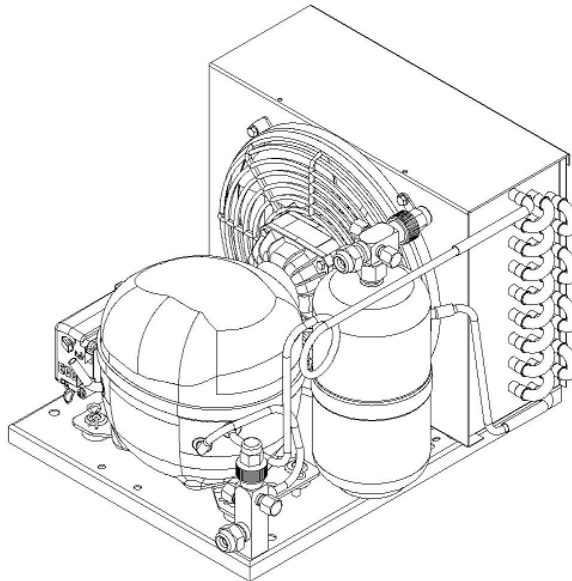
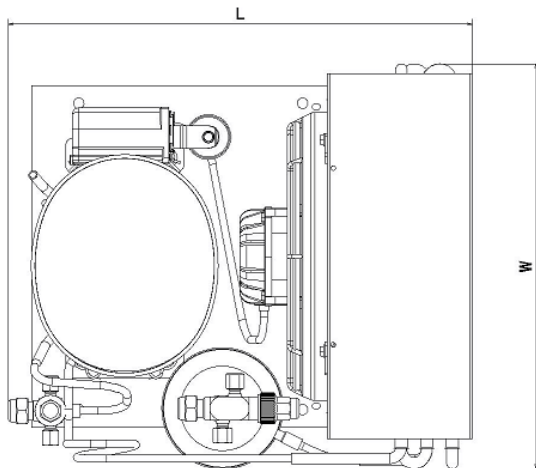
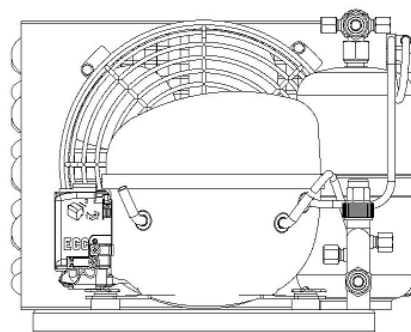
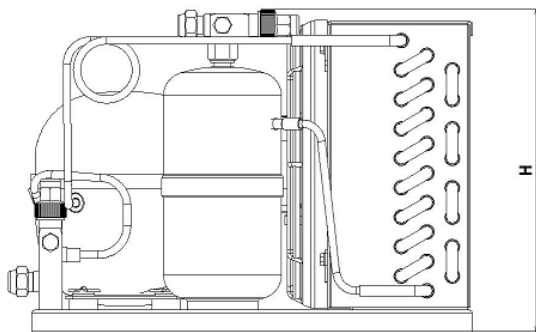

VERSION 1-4 (WxLxH) (mm)	VERSION 2 (WxLxH) (mm)	VERSION 3 (WxLxH) (mm)	VERSION 3P (WxLxH) (mm)
315x385x235	315x425x235	320x425x235	330x435x245